

User Guide Dialog 3213

System telephone for MD110, release BC7-BC10



Welcome to the User Guide for the Dialog 3213 telephone in the Ericsson Enterprise business communication system MD110, release BC7-BC10.

It is a state-of-the-art business communications system. Its alliance of features and facilities effectively improves communications for virtually any kind of organization.

To take full advantage of these advanced features and facilities there is a line of telephones, designed for ease of use in every situation.

Your phone is equipped with programmable keys for single-key access to frequently used functions and numbers. Step-by-step instructions in the display assist your actions on the phone. Only a selected number of display images, however, are shown in the User Guide for your reference.

Function descriptions that do not include speaking in the handset, are described off-hook, if nothing else is stated. Instead of pressing the "Clear-key", you can always replace the handset.

Some markets use differing codes for some functions. In this guide, all functions are described using the most common code for every specific function. As a note the markets and their differing code is shown.

The User Guide describes the facilities of the Ericsson Enterprise communication system and the Dialog 3213 telephone as they are programmed at delivery from the factory. There may be some differences in the way your phone is programmed. Please consult your system administrator if you need further information.

Note: *Dialog 3213 is a system telephone, i.e. it can only be used for an Ericsson private branch exchange that supports this type of telephone.*

Table of Contents

	page
Description	4
Incoming Calls	6
Outgoing Calls	8
During Calls	11
When You Receive a Busy Tone	17
Call Forwarding	21
Internal Messages	32
Voice Mail	34
Information	37
Abbreviated Numbers	39
Call Metering	44
Group Facilities	46
Other Useful Facilities	48
Paging (optional)	57
Authority	62
Programming and Adjustments	67
Audible Signals	76
Visible Signals	78
Display Information	79
Option Unit/Vocabulary	83
Installation	84
Labels	87
Index	88

EN/LZT 102 2553 RE

© Ericsson Enterprise AB 2001

All rights reserved. No parts of this publication may be reproduced, stored in retrieval system, or transmitted in any form or by any means, electronic, mechanical, photocopying, recording or otherwise, without prior written permission of the publisher.

Description

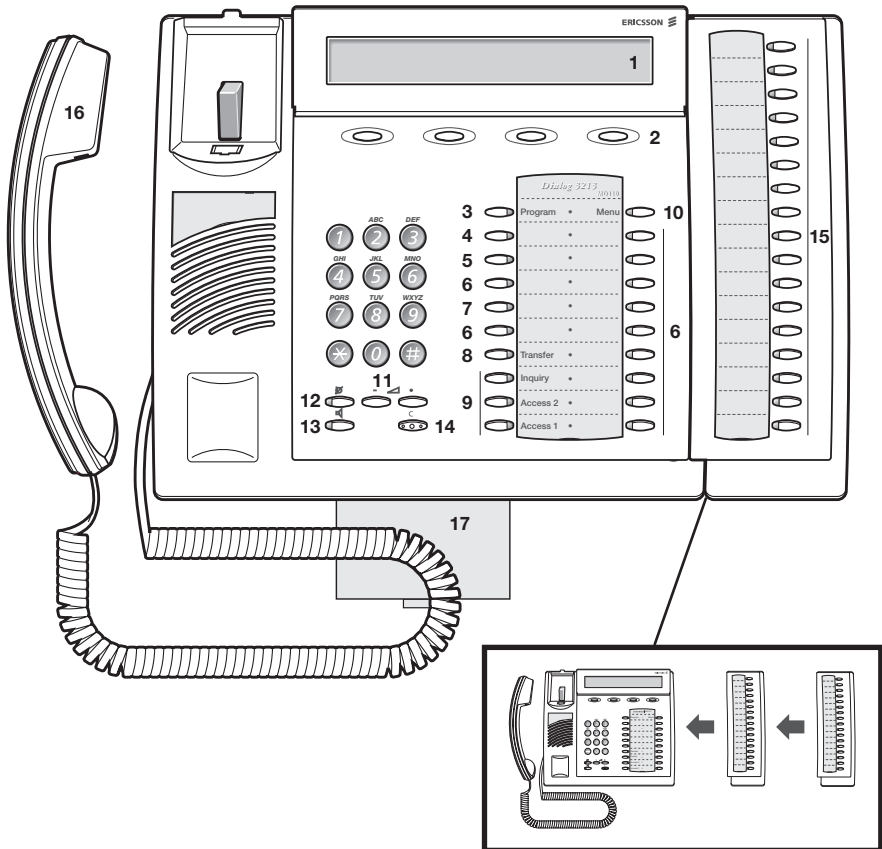

- 1 **Display**
3x40 characters. See section "Display information".
- 2 **Soft keys**
The functions depend on the traffic state. When you are requested to "(see display)", press the required key to access the function.
- 3 **Programming**
See section "Programming".

- 4 Callback**
See section "When you receive a busy tone". Function can be removed or moved to other programmable function key by system administrator.
- 5 Diversion (follow-me)**
See section "Call forwarding". Function can be removed or moved to other programmable function key by system administrator.
- 6 Programmable function keys**
See section "Programming".
- 7 Programmable function key/Headset key**
Normally a programmable function key as described at 6. With Option unit DBY 410 02 (optional accessory) installed under the telephone, the key is dedicated to be programmed by the system administrator as the Headset key. See section "Other useful facilities/Headset".
- 8 Transfer**
See section "During calls".
- 9 Triple access line**
For handling calls. Access 1 and 2 are available both for incoming and outgoing calls. Inquiry can only be used for outgoing calls.
- 10 Menu key**
When the telephone is in idle state, press to switch between "idle message" and soft key descriptions.
- 11 Volume control**
See section "Adjustments".
- 12 Mute**
 - a) To switch the microphone on or off during a call.
 - b) To switch off the ringing signal in idle state or when ringing. See sections "During calls" and "Audible signals".
- 13 Loudspeaker on/off**
See section "During calls".
- 14 Clear**
To disconnect calls, exit a function or clear the display in programming. Can always be pressed instead of replacing the handset.
- 15 Optional key panel**
With 17 dual-function programmable keys. One or two panels can be connected.
- 16 Handset**
Supplied with hearing aid function as standard.
- 17 Optional pull-out leaf for easy guide**
See inside of the back cover.

Incoming Calls

Answer calls



A ringing signal and a flashing lamp indicate an incoming call.

On Access 1

Normally you will receive calls on the Access 1 line.



Lift the handset

On any other line key



Lift the handset



Press the flashing line key

Handsfree



Press the flashing line key

You are connected to the caller via the loudspeaker and microphone.



Press to terminate a handsfree call

On another extension

You can answer a call to a phone in another room:

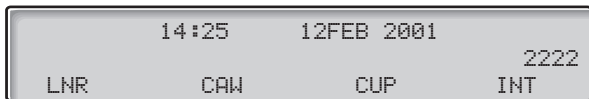
**Call the ringing extension**

Note: The display image might differ from the above.

8 Press**Notes:**

- You can also press **CUP** (see display) or On-hold/Pick-up (function key pre-programmed by you).
- France-press **4**; Sweden-press **6**

Answer a second call during an ongoing call

If your telephone is pre-programmed with a "Free on 2nd access" key, you can receive another call, if this function is activated.

**Press to activate / deactivate**

When Free on 2nd access is active the lamp is lit.

Note: Function key pre-programmed by system administrator.

You have an ongoing call on Access 1, when the Access 2 key flashes to indicate a new incoming call:

**Access 2****Press to answer**

The first call is put on hold.

**Access 1****Press to switch back to the first call**

The second call is put on hold. You are connected to the first caller.

**Press to terminate the connected call**

Note: If the calling party has activated Call waiting, you can receive a second call even if Free on 2nd access is not activated.

Outgoing Calls

Make calls

How to make internal and external calls:



Lift the handset and proceed depending on call type:

Internal calls



Dial the extension number

External calls

0

Dial the digit or digits to get an external line

Dial tone.

Note: The particular digit or digits used in your office, e.g. 0 or 00.



Dial the external number

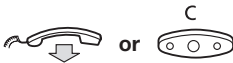

Press to end the call

Note: If you receive a queue tone when the digit or digits to get an external line are dialled (optional function Least Cost Routing is used in the system), keep waiting. Once a line becomes free you will receive a dial tone. If a warning tone is heard, the selected line is marked "Expensive".

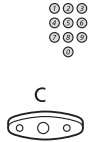

Handsfree

With the handset on hook:

Dial the number

You are connected via the loudspeaker and microphone.

Press to terminate a handsfree call

Note: You can make your calls faster by using common abbreviated numbers and by using your own programmed abbreviated numbers. See section "Abbreviated numbers".

Individual external line

To make a call on a specific external line:

* 0 *

Press

000
000
000 #

Dial the individual external line number and press

000
000
000
0

Dial the digit or digits to get an external line and the external number

Last external number redial

When you initiate an external call the system automatically stores all the dialled digits, irrespective of whether the call was successful or not.



Lift the handset

* * *

Press to redial the saved number

The last external number is automatically redialled.

Notes:

- You can also press LNR (soft key). LNR is only available if shown in display.
- Finland and Sweden-press * * 0

Save external number

When you make an external call, you can save the number in order to redial the same number easily. Any previously saved number is erased.

To save an external number:



Press before you finish the call

Note: Function key pre-programmed by system administrator.

Redial number



Lift the handset



Press to redial the number

Note: Function key pre-programmed by system administrator.

During Calls

Group listening (loudspeaking)

This function lets other people in your room listen to your telephone conversation. You speak in the handset while the other party's voice is heard on the loudspeaker.

During an ongoing conversation:



Press to switch between loudspeaker and handset

When the key lamp is lit, the other party's voice is heard on the loudspeaker.

Note: You can adjust the volume, See section "Adjustments".

From loudspeaking to handsfree



Replace the handset

Handsfree conversation.

From handsfree to loudspeaking



Lift the handset and press



Press to end the call



From handset to handsfree

Press and replace the handset
Handsfree conversation.



Press to end the call

From handsfree to handset



Lift the handset
Conversation via the handset.

Mute



Press to switch the microphone on or off
When the lamp is lit, the person on the line cannot hear what is being said in your room.

Inquiry

You have speech connection on Access 1 and want to make an inquiry to an internal or external party.



Inquiry

Press

Note: *You can also press Access 2.*



Call the second party

The first party is put on hold (the Access 1 key lamp flashes slowly). When the other party answers you can switch between the calls (refer back), transfer the call, create a conference and end one of the calls.

C



Press to end the inquiry call

The second party is disconnected.



Access 1

Press to return to the first party

Refer back

The key lamp flashes for the call put on hold.



Access 1

Press to put second party on hold

First party is connected.



Inquiry

Press to put first party on hold

Second party is connected.

C



Press to terminate the connected call

Transfer

You want to transfer an ongoing call.



Inquiry

Press



Call the second party



Transfer

Press before or after answer

The ongoing call is transferred.

Note: *If you have put more than one call on hold, the last call that was put on hold will be transferred. If the dialled extension is busy or transfer is not allowed, your phone will ring again.*

Conference

With this procedure you can include up to seven parties in a conference. Only the conference leader can admit participants. During the conference a tone will be heard every 15th second.

You have an ongoing conversation (Access 1) and want to establish a telephone conference. You will become the conference leader.



Inquiry

Press

Note: *You can also press Access 2.*



Call the second party

Wait for answer.

3

Press to establish a conference

Note: *You can also press: CONF (see display) or Conference (function key pre-programmed by you).*

Repeat the procedure to add more conference members



Replace the handset to leave the conference

On hold

You can temporarily put the ongoing call on hold. Calls put on hold can be resumed on your own telephone or another.

Individual



Press the ongoing call line key and replace the handset

The key lamp flashes slowly.



Press the line key again to resume the call

Common

8 Press

Notes:

- You can also press: CUP (see display) or On hold/Pick-up (function key pre-programmed by you).
- France-press **4**; Sweden-press **6**



Replace the handset

The key lamp flashes slowly.

To resume the call on your own extension:



Press the line key

To resume the call on another extension:



Call the extension where the call was put on hold

8 Press

Notes:

- You can also press: CUP (see display) or On hold/Pick-up (function key pre-programmed by you).
- France-press **4**; Sweden-press **6**

Send caller identity code at transfer

When transferring a call you can send the caller's identity code or number to the receiver's display.

You have speech connection with an external party on Access 1.



Inquiry

Press to put the call on hold

Note: You can also press Access 2.

*** 7 7 ***

Press

**⓪⓪⓪
⓪⓪⓪
⓪⓪⓪
⓪** **#**

Dial the caller's identity code or number and press

**⓪⓪⓪
⓪⓪⓪
⓪⓪⓪
⓪**

Call the second party



Transfer

Press before or after answer

The ongoing call is transferred with the caller's identity code or number.

Note: You can only use this function if the receiver's telephone is programmed to handle identity codes. This function is only available in newer versions of the telephone exchange.

Dialling during a connected call

When calling interactive tele services, e.g. telephone banks, you need to use Dual Tone Multi Frequency (DTMF) signals. If your exchange is not already programmed to automatically convert your entered digits into DTMF signals, you need to activate the function during the call.

During an ongoing call:

9 **⓪⓪⓪
⓪⓪⓪
⓪⓪⓪
⓪**

Press and dial the requested digits

Entered digits are transferred as DTMF signals.

Notes:

- You can also press ETE (see display).
- Finland-press **1** and dial the required digits.

When You Receive a Busy Tone

Busy extension or external line

If you call an extension and receive a busy tone or get no answer or all external lines are busy you can use these methods:

Automatic callback

If a called extension is busy or there is no answer:

14:25	12FEB 2001		
EXTENSION BUSY			4444
LNR	CAW	CUP	INT

6 Press

Notes:

- You can also press: CAB (see display) or Callback (function key pre-programmed by you).
- Finland and Sweden-press **5**



Replace the handset to finish procedure

You are called back (recall ringing signal) when the ongoing call is finished or the next time a new call is finished. You have to answer within eight seconds, otherwise the Callback service is cancelled.



Lift the handset when you are called back

The system calls the extension.

Note: Callbacks can be activated on several extensions at the same time. Callbacks from additional lines will recall on the Access 1 line.

If all external lines are busy (after dialling the digit or digits to get a line):

6 Press

Notes:

- You can also press: CAB (see display) or Callback (function key pre-programmed by you).
- Finland and Sweden-press 5



Dial the external number and press



Replace the handset to finish procedure

When an external line becomes free you will be called back (recall ringing signal). You have to answer within eight seconds, otherwise the Callback service is cancelled.



Lift the handset when you are called back

The system calls the external number.

Note: Only one Callback can be activated on a busy external line. Callbacks from additional lines will recall on the Access 1 line.

Cancel any single callback

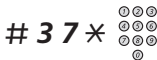

Press and dial the extension number

Note: To cancel a single Callback on a specific external line, dial the digit or digits to get a line instead of the extension number.



Press

Cancel all callbacks



Press



Press

Activate call waiting

If you urgently wish to contact a busy extension or external line, you can notify it by a call waiting signal.

5 Press

Notes:

- You can also press: CAW (see display) or Call waiting (function key pre-programmed by you).
- France and Finland-press **6**; Sweden-press **4**

Keep handset off-hook. When the called extension or the external line becomes free, it will be called automatically.

Note: *The call waiting function might be blocked for use on your extension (programmed by system administrator). If call waiting is not allowed you will continue to receive a busy tone.*

Intrusion on a busy extension

You can intrude on an ongoing call on a busy extension.

4 Press

Note:

- You can also press: INTR (see display) or Intrusion (function key pre-programmed by you).
- France and Sweden-press **8**

Before the intrusion is executed a warning tone is sent to the parties in the ongoing call. A three party call is established and a warning tone is heard.

Note: *The Intrusion function might be blocked for use on your extension (programmed by system administrator). If Intrusion is not allowed you will continue to receive a busy tone.*

Intrusion on a busy external line

You can intrude on an ongoing call on a busy external line.

*** 4 4 *** 

Press and dial the individual external line number



Press and dial the digit or digits to get an external line

Busy tone.

4 **Press**

Notes:

- You can also press: *INTR* (see display) or *Intrusion* (function key pre-programmed by you).
- France and Sweden-press **8**

Before the intrusion is executed a warning tone is sent to the parties in the ongoing call. A three party call is established and a warning tone is heard.

Note: *The Intrusion function might be blocked for use on your extension (programmed by system administrator). If Intrusion is not allowed you will continue to receive busy tone.*

Call Forwarding

Diversion

If you do not want to be disturbed or will be out of the office, you can have all calls to your extension diverted to a pre-programmed answering position. During diversion you will hear a special dial tone and the diversion lamp indicates that your triple access line is diverted. You can still make calls as usual.

Diversion can be direct, on no answer, on busy or to another information service facility.

Note: *If your telephone is programmed with "Multiple Directory Diversion and Do not disturb" (ask your system administrator), Diversion is ordered and cancelled simultaneously on all lines.*

Order direct diversion from your own extension

The call is diverted to an individual position or up to three pre-determined common answering positions (depending on the type of the incoming call). Programmed by the system administrator.



Diversion

Press

Note: *Function key pre-programmed by system administrator. If you order diversion with the handset off-hook or the loud-speaker on, press the diversion key twice. You can also use the procedure below.*

* 2 1 #

Press

Note: *U.K.-press * 2 #*



Press

Note: *Diversion can also be ordered and cancelled from the answering position, use the same procedure as in section "Internal follow-me".*

Cancel direct diversion from your own extension



Press

Note: Function key pre-programmed by system administrator. You can also use the procedure below.

2 1

Press

Note: U.K.-press **# 2 #**



Press

Note: Diversion can also be ordered and cancelled from the answering position, use the same procedure as in section "Internal follow-me".

Diversion when there is no answer

*** 2 1 1 #**

Press to order

Note: Finland and Norway-press *** 6 1 #**

The incoming call is diverted after 3 signals.



Press

2 1 1

Press to cancel

Note: Finland and Norway-press **# 6 1 #**



Press

Diversion when caller receives a busy tone

✖ 2 1 2 #

Press to order

Note: *Finland and Norway*-press **✖ 6 7 #**



Press

2 1 2

Press to cancel

Note: *Finland and Norway*-press **# 6 7 #**



Press

Diversion to another information service facility

✖ 2 1 8 #

Press to order



Press

2 1 8

Press to cancel



Press

Internal follow-me

All calls to your extension are diverted to an extension of your choice (within the private network). During follow-me you will hear a special dial tone and the diversion lamp indicates that your triple access line has follow-me. You can still make calls as usual.

Note: *If your telephone is programmed with "Multiple Directory Diversion and Do not disturb" (ask your system administrator), Internal follow-me is ordered and cancelled simultaneously on all lines.*

Order from your own extension



Lift the handset



Press and dial the answering position number

Note: *Function key pre-programmed by system administrator.*



Press to order



Replace the handset

Note: *You can also use the procedure below.*

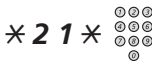

Press and dial the answering position number

Note: *U.K.-press * 2 * No.*



Press

Cancel from your own extension



Press

Notes:

- *Function key pre-programmed by system administrator.*
- *You can also use the procedure below.*

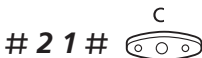

Press

Note: *U.K.-press # 2 #*

Redirect from answering position

*** 2 1 *** 

Press and dial your own extension number

Note: U.K.-press * 2 * No.

***** 

Press and dial the diversion number



Press to redirect

Calls are diverted to the answering position.

Note: Internal follow-me must be ordered from your own extension before you can redirect from answering position.

Cancel from answering position

2 1 * 

Press and dial your own extension number

Note: U.K.-press # 2 * No.



Press

External follow-me

If external follow-me is allowed you can have all calls to your extension diverted to an external number of your choice. A special dial tone will be heard. You can still make calls as usual.

Order

* 2 2 # 

Press and dial the digit or digits to get an external line and the external number



Press

Cancel

 Diversion

Press

Note: Function key pre-programmed by system administrator. You can also use the procedure below.

2 2

Press



Press

Bypass diversion

If bypass diversion is allowed from your extension, you can bypass an activated diversion/follow-me on a specific extension.

* 6 0 * 

Press and dial the extension number

#

Press and wait for answer

Personal number (optional)

With this function you can be reached on your normal office telephone number even if you are in another room, out of the office, at home, etc.

Depending on the functionality of your office exchange, you can have either one individual single search profile or you can choose between five individual search profiles. A search profile can be designed to fit the situation, i.e. In the office, On travel, At home, etc. Both internal or external telephone numbers can be used in a profile.

On your request, the search profiles are programmed or modified by the system administrator. See section "To design and order your search profiles".

When the function is activated, incoming calls are transferred to different telephones or back-up services in your decided order. If an answering position in the profile is busy, the call can be transferred to another predefined position in the profile, i.e. Voice mail or a colleague. You can activate the function from your own office telephone or when out of the office, by using the Direct Inward System Access function (DISA).

To activate or change to another profile from your office telephone

✖ 1 0 ✖

Press

(1 - 5)

Dial the search profile digit



Press

The display shows the chosen search profile digit.

Note: If the operator is included in the activated profile as an answering position, always inform the operator if you are absent. Use the Absence information function or call the operator. If Voice Mail is included in the activated profile, always update your greeting with absence information.

To cancel from your office telephone

1 0

Press



Press

To activate or change to another profile from an external telephone

The external telephone must be of push button type provided with hash (#) and star (*) keys or a mobile telephone adapted for dial tone pulses (DTMF).

Call the DISA function at your office

Dial tone.

*** 7 5 ***

Press



Enter the authorization code and press



Dial your own extension number and press

Dial tone.

*** 1 0 ***

Press



Dial your own extension number and press

(1 - 5)

Dial the search profile digit



Press and replace the handset

Note: *If the operator is included in the activated profile as an answering position, always inform the operator if you are absent. Use the Absence information function or call the operator. If Voice Mail is included in the activated profile, always update your greeting with absence information.*

To cancel from an external telephone

The external telephone must be of push button type provided with hash (#) and star (*) keys or a mobile telephone adapted for dial tone pulses (DTMF).

Call the DISA function at your office

Dial tone.

* 7 5 *

Press



Enter the authorization code and press



Dial your own extension number and press

Dial tone.

1 0 *

Press



Dial your own extension number and press



Replace the handset

To design and order your search profiles

The search profiles are installed or changed by the system administrator. In order to set up your profiles, copy the setting form, fill in your new or changed profiles and give it to your system administrator.

Note: *If Personal Screen Call Server is connected to your system, you can edit the profiles via your Intranet. See instructions for the server!*

Important notes when designing your search profiles:

- *Avoid a ringing time longer than 45 seconds for your profiles*
Usually the caller hangs up after 3-6 ringing signals. If you need a longer ringing time, the maximum time is 60 sec.
- *Consider the time you need to react and answer on each answering position in your profiles*
You might need up to 15 seconds to react and answer on a desk or cordless telephone and 20-25 seconds for a mobile telephone.

- *There must be an answering position at the end of every profile (voice mail or operator/secretary)*

If not, calls might end up unanswered.

- *Consider what should happen when you are busy on a telephone*
The available options are:

- *Activate Free on 2nd (if available)*
- *Diversion to Voice mail*
- *Diversion to the operator*

- *If an answering machine, a FAX or other answering service is used as an early answering position, it might interrupt the searching*
Disconnect the answering service, or design the ringing times so they do not affect the searching.

- *If your system admits just one single personal profile, design the profile only with your 2-3 most frequently used positions*
If you add more numbers, there is a risk that the caller hangs up before a late position is called.

- *If your system admits 1-5 personal profiles, design the different profiles to fit your most used positions*

Make sure you use as few answering positions as possible for each profile. Profile examples:

- *In office*
- *At home*
- *On travel*
- *Absent/not reachable*

Example:

How to fill in your setting form for search profiles:

Profile 1 In office

<i>Search order</i>	<i>Type of telephone or answering position*</i>	<i>Telephone number</i>	<i>Ringing time (seconds)</i>
1	Desk	1234	10
2	Cordless	5234	15
3	Voice Mail		

** Examples: Desk, Cordless, Mobile, External, Voice Mail, Operator, etc.*

Profile 2 At home

<i>Search order</i>	<i>Type of telephone or answering position*</i>	<i>Telephone number</i>	<i>Ringing time (seconds)</i>
1	External	222222	20
2	Mobile	0706666666	25
3	Voice Mail		

Setting form for search profiles

Name: Department:
 Telephone No: Account:

Profile 1

<i>Search order</i>	<i>Type of telephone or answering position*</i>	<i>Telephone number</i>	<i>Ringing time (seconds)</i>
1			
2			
3			
4			

* Examples: Desk, Cordless, Mobile, External, Voice Mail, Operator, etc.

Profile 2

<i>Search order</i>	<i>Type of telephone or answering position*</i>	<i>Telephone number</i>	<i>Ringing time (seconds)</i>
1			
2			
3			
4			

Profile 3

<i>Search order</i>	<i>Type of telephone or answering position*</i>	<i>Telephone number</i>	<i>Ringing time (seconds)</i>
1			
2			
3			
4			

Profile 4

<i>Search order</i>	<i>Type of telephone or answering position*</i>	<i>Telephone number</i>	<i>Ringing time (seconds)</i>
1			
2			
3			
4			

Profile 5

<i>Search order</i>	<i>Type of telephone or answering position*</i>	<i>Telephone number</i>	<i>Ringing time (seconds)</i>
1			
2			
3			
4			

Internal Messages

Manual message waiting (MMW)

If the called extension does not answer you can initiate a message waiting indication on that extension (if this function is allowed).

Answer



Message

Press

Note: Function key pre-programmed by system administrator.

A call is initiated to the extension that requested message waiting.

Checking the party that requested MMW



Program

Press

The program key lamp turns on and all other lamps turn off.



Message

Press

Note: Function key pre-programmed by system administrator.

The number that requested message waiting is shown in the display.



Program

Press to finish procedure

Cancel MMW at your own extension

3 1

Press



Press

Order MMW to another extension*** 3 1 *****Press****Dial the extension number****Press**

The message waiting key lights up on the called extension.

Cancel MMW to another extension**# 3 1 *****Press****Dial the extension number****Press****Message waiting (optional)**

If assigned this function and your telephone is diverted to an interception computer, a function key (programmed by the system administrator) will flash when there are messages stored for you in the computer. The messages will be printed out on a printer connected to the computer.

To print out messages**Press**

The display shows the identity of the computer and the number of messages stored for you.

If you find that the notification of message waiting is intrusive or you want to shut off the notification:

9 1 # ***Press**

Acknowledgement tone.

Voice Mail

Integrated voice mail (optional)

This function allows you to leave a voice message to the caller when you are unable to answer calls, e.g. when out of office, in a meeting, etc. Then the caller can leave a message in your mailbox. When back in office you can enter your mailbox and listen to received messages.

You can choose to divert all incoming calls to your mailbox, or calls when there is no answer, or calls when your telephone is busy.

When you enter your mailbox, you will hear recorded instructions how to handle listening, recording, storing and deleting messages, and how to change your security code.

To activate and deactivate your mailbox

For all incoming calls:

See Call Forwarding, section Internal Follow-me (function code 21). Use the number to the voice mail system as the "answering position number".

When incoming calls get no answer:

See Call Forwarding, section Diversion when there is no answer (function code 211).

When incoming calls get a busy tone:

See Call Forwarding, section Diversion when caller receives a busy tone (function code 212).

To enter your mailbox

From your office telephone:

**Dial the number to the voice mail system**

Note: *If a function key is programmed for your mailbox and the key lamp is lit (= a new message is received), you can also press this key.*

If you are asked to enter your security code:

**Enter your security code**

Code at delivery = your extension number.

From another telephone:

**Dial the number to the voice mail system**

If you are asked to enter your security code (the used telephone has a mailbox of its own):

#**Press****Enter your mailbox number**

(normally your office extension number)

**Enter your security code (if required)****To enter someone else's mailbox****Dial the number to the voice mail system**

If you are asked to enter your security code (the used telephone has a mailbox of its own):

#**Press****Enter the mailbox number**

(normally the office extension number of the person served)

**Enter the security code of the person served (if required)**

To handle the mailbox

Recorded information on the line informs about the number of new and stored messages. If you have too many messages stored, you will first be asked to delete saved messages.

Recorded instructions ask you to press different digits in order to listen to caller's messages, record your own greetings, change your password or exit your mailbox, etc.

The following diagram gives an overview of the mailbox system and the digits to be used.

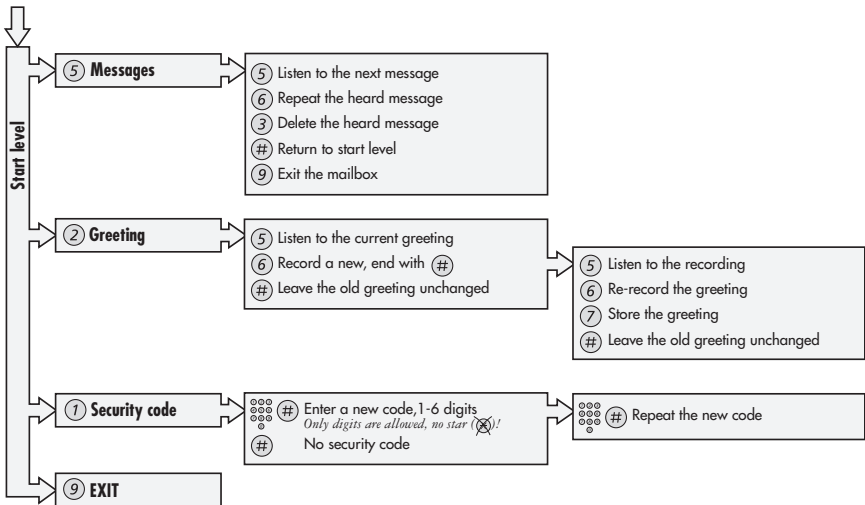

Information

Absence information (optional)

To be used during absence to inform callers about the reason and time or date of your return. If you are authorized, you can also enter absence information on another extension from your own extension.

Order

Example: Back on September 15th (=0915).

*** 2 3 ***

Press

(0-9)

Enter the absence code

Note: *The absence codes consist of one digit which depends on the system connected to the exchange. Contact your system administrator regarding your available absence codes.*

*** 0 9 1 5**

Press and enter the date (MMDD) or time (HHMM) of your return

Note: *If no return time or date is needed, this step can be excluded.*



Press

The display shows the reason, and if entered, time or date of return.

Cancel

2 3

Press



Press

The programmed information is erased.

Order for another extension

*** 2 3 0 ***

Press



Dial the extension number and press

(0-9)

Enter the absence code

*** 0 9 1 5**

Press and enter the date or time of the other person's return



Press

The display on the other person's extension shows the reason, and if entered, time or date of return.

Cancel for another extension

2 3 0 *

Press



Dial the extension number and press

Note: If the special dial tone is received, the authorization code for the other extension is required. Add the code and press # before pressing the Clear key.



Press

Abbreviated Numbers



Common abbreviated numbers

By using abbreviated numbers, you can make calls simply by pressing a few keys. The common abbreviated numbers consist of 1-5 digits and are stored in the exchange (by the system administrator).

Lift the handset and dial the common abbreviated number

Individual abbreviated numbers

You can program up to ten frequently used telephone numbers on the digit keys 0-9 and use them as individual abbreviated numbers (if this function is allowed).

Note: *In Finland up to nine numbers, keys 1-9.*

To use

*** * (0-9)**

Press and dial the relevant digit

Note: *Finland-press **(1-9); Sweden-press (0-9)#*

Program and alter individual abbreviated numbers

*** 5 1 * (0-9)**

Press and dial selected digit

Note: Finland-press *51*(1-9)



Press and dial the telephone number



Press

Note: The programmed number may consist of a maximum of 20 digits plus a "*", which indicates the second dial tone from the public network. The display only shows the last 20 characters in a number.

Erase one programmed number

5 1 * (0-9)

Press and dial selected digit

Note: Finland-press #51*(1-9)



Press

Erase all programmed numbers

5 1

Press



Press

Dial-by-name (optional)

By use of the Integrated Telephone Directory you can search for a name, group, operator, etc. via your display and then call the wanted person or group by use of a soft-key below the display.

DIR **Press (see display)**
The display shows:

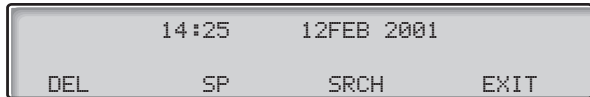

DEL **Press to delete the last entered character (see display)**

SP **Press to enter a space (see display)**

SRCH **Press to search using the entered characters (see display)**

EXIT **Press to return to the previous menu (see display)**

Use the key pad to enter the characters of the name.
The characters above the keys show the key to be pressed.

Example:

Select characters by pressing digits repeatedly. The cursor is moved automatically when you stop pressing.



Press a digit

1 time result A
2 times result B
3 times result C

When the requested character is shown on the display, wait for the cursor to move to the next place.

The name must be entered as follows:

Family name - Space - Name

It is not necessary to enter all the characters, just as many to get as close as possible to the requested name when you start to search.

Note: *If you want to specify the person's first name, you must enter the full family name before you can enter a space.*

Example:

To search for Bob Smith:

7 7 7 7

Press for S

6

Press for m

4 4 4

Press for i

The display shows:

	14:25	12FEB 2001		
SMI				
DEL	SP	SRCH	EXIT	

SRCH

Press to search (see display)

If SMI was sufficient to find Bob Smith, the display shows:

SMITH BOB			54321	
UP	DOWN	DIAL	EXIT	

If SMI gives a name close to Bob Smith, e.g. Ann Smith, scroll down until you find the requested name.

UP

Press to scroll up trough the name list (see display)

DOWN

Press to scroll down trough the name list (see display)

DIAL

Press to dial the number displayed (see display)

BACK

Press to return to the previous menu (see display)

If there is additional information in the directory for the name being displayed, this is shown under the name, e.g. company, country, etc.

The display will inform if no name matches your search and show the name alphabetically preceding the entered one.

Dial by a function key

Head office 

Press the function key

Program

Both telephone numbers and function codes can be programmed on a function key.

 **Program**

Press



Press the selected function key and dial the telephone number or function code



Press the function key again

 **Program**

Press to finish programming

Assign the key.

Verify and erase programmed number

 **Program**

Press



Press the selected function key

The stored number is shown on the display.



Press if you want to erase the stored number

The stored number is erased.

 **Program**

Press

Call Metering

Charging information

Charging information for your call can be shown in the local currency in the display.

	14:25	12FEB 2001	
COST IN £	3.25		2222
ETE		COST	TIMER

COST **Press to display or hide the cost indication (see display)**

Note: The cost indication is automatically displayed for all charged calls, when the function is activated.

Timer

You can measure the elapsed time of your call.

	14:25	12FEB 2001	
			2222
START	RST	DATE	EXIT

TIMER **Press to activate the timer (see display)**

START **Press to start the timer function (see display)**

The display changes and the elapsed time is shown.

STOP **Press to stop the timer function (see display)**

EXIT **Press to exit the timer function (see display)**

Note: Timer can be activated when your telephone is idle, ready for dialling, during an outgoing call or when in speech connection.

Other functions

These functions are also available, during timer mode:

- DATE **Press to show date (see display)**
- TIME **Press to display time measurement (see display)**
- RST **Press to clear time measurement (see display)**

Group Facilities

Call pick-up group

People working in a team can have their telephones programmed by the system administrator to form Call Pick-up groups.

In a Call Pick-up group, any member can answer any individual call to group members.

8 Press to answer

Notes:

- You can also press *PICK* (see display).
 - Finland and Sweden-press **0**
 - One Call Pick-up group can serve as an alternative to another group. Calls to the alternative group can only be answered when there are no calls to your own group.
-

Common bell group

Calls are signalled on a common bell.

8 Press to answer

Notes:

- You can also press *PICK* (see display).
- Finland and Sweden-press **0**

Group hunting

As a member of a group of extensions that is called by a common number, you can temporarily leave the group.

✖ 2 1 ✖ 

Press and dial your own extension number

Note: *U.K.-press ✖ 2 ✖ No.*



Press

To re-enter the group

2 1

Press

Note: *U.K.-press # 2 #*



Press

Other Useful Facilities

Account code (optional)

This function is used to charge a call to an account number or to prevent unauthorised calls from your telephone. The account code can have 1 to 15 digits.

✳ 6 1 ✳

Press

Note: *Finland and Norway-press ✳ 7 1 ✳*

⓪⓪⓪
⓪⓪⓪ #
⓪⓪⓪
⓪

Enter the account code and press

Dial tone.

Note: *You can also press ACO (see display), enter the account code and press ENTER (see display).*

⓪⓪⓪
⓪⓪⓪
⓪⓪⓪
⓪

Dial the digit or digits to get an external line and the external number

Ongoing external call

When used to charge a call it is also possible to connect an ongoing external call to an account code. During the call:



Access

Press the line key to put the ongoing call on hold

✳ 6 1 ✳

Press

Note: *Finland and Norway-press ✳ 7 1 ✳*

⓪⓪⓪
⓪⓪⓪ #
⓪⓪⓪
⓪

Enter the account code and press

Dial tone.

Note: *You can also press ACO (see display), enter the account code and press ENTER (see display).*



Access

Press the line key for the call put on hold

Immediate speech connection

You automatically answer a call without lifting the handset or pressing any keys. The function can be permanently active or activated by use of a function key (programmed by system administrator).

Permanently active

Program the ringing option with "Immediate speech connection with single tone burst", option 6, on the Access line key. See section "Programming".

Activated on a function key

Automatic answer 

Press to order or cancel

Note: *Function key pre-programmed by system administrator.*

The incoming call is signalled with a tone burst. When the key lamp is lit you can use this function.

General cancellation

The following features can be simultaneously cancelled:

- Callback (all Callbacks are cancelled).
- Diversion/Internal and External Follow-me.
- Manual message waiting/Message diversion.
- Do not disturb.
- Flexible night service.

Order

0 0 1



Press

Press

Night service

When the exchange is in night service mode, all your incoming calls to the operator are transferred to a selected extension or group of extensions. The exchange is equipped with four different night service modes:

Common night service

All incoming calls to the operator are transferred to one specific extension. Answer the call in the normal way.

Individual night service

Selected external calls to the operator are transferred to one specific extension. Answer the call in the normal way.

Universal night service

All incoming calls to the operator are transferred to a universal signalling device, e.g. the common bell. Answer the call as described in section "Common bell group".

Flexible night service

This function permits you to order an external line and connect it directly to your telephone. Ask your operator for the external line numbers.

To order flexible night service

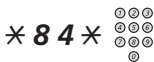

Press and dial the digit or digits to get a line



Press and dial the external line number



Press

Cancel



Press and dial your own extension number



Press

Hot line

Ask your system administrator if you require this function.

Delayed hot line

When the handset of the delayed hot-line telephone is lifted or when the line key is pressed, a timer is started. If no digit is pressed before time out, a call is automatically generated to a specific extension or external line. If a digit is pressed before time out the telephone works as an ordinary telephone.

Note: *This function is only available in newer versions of the telephone exchange.*

Direct hot line

The same function as described above, but no delay. Only hot line calls can be placed from this line. To be used e.g. as alarm phone, door phone etc.

Alarm extension

An extension can be programmed by system administrator as an alarm extension. A call to an alarm extension obtains automatic intrusion if the extension is busy. Up to seven calling parties may be connected at the same time.

Emergency state

In the event of an emergency the operator can switch the exchange into emergency state, during which only pre-programmed extensions are permitted to make calls.

Data communication

Your telephone can be used together with a PC as an integrated voice and data terminal. Contact your system administrator if you require this function.

Additional directory number

You can be assigned (programmed by system administrator) one or more additional directory numbers (lines) on free function keys.

To answer, make calls and use functions on the additional directory lines, use the same procedure as for triple access lines if nothing else is stated. However, you have to press the additional line key after lifting the handset.

Example:

To make a call on an additional directory line:



Lift the handset



Press

Note: Function key pre-programmed by system administrator.



Dial the extension number

Multiple represented directory number

Your extension number can be multiple represented on other digital system telephones, i.e. the number is represented as a key on these telephones. Your incoming calls can be answered on any of these telephones by just pressing your dedicated key. In idle state this key can be assigned to call your number by just pressing the key. Contact your system administrator if you require this function.

Malicious call tracing

If you are disturbed by malicious external incoming calls, you can request a number tracing from the network provider.

You can invoke tracing during or after an ongoing conversation. The external line can be held for a limited period of time.

Order

During an ongoing conversation:

*** 3 9 #**

Press

Note: You can also press MCT (see display) or Mal. Call Tracing (function key pre-programmed by system administrator).

The system acknowledges with different tones whether the tracing request was accepted or rejected.

Headset

If your telephone is equipped with Option unit DBY 410 02, the following headset functions are available.

Note: How to install Option unit and headset, see installation instruction provided with the Option unit.

Activate/Deactivate the headset



Headset

Press the headset key to activate/deactivate the headset

Note: Function key pre-programmed by system administrator.

See section "Description". All calls can be handled via the headset.

Answer calls



Press the flashing line key to answer



Press to terminate a headset call

Make calls



Dial the number



Press to terminate the call

Headset to handset



Lift the handset

Handset to headset



Press the headset key

Note: Function key pre-programmed by system administrator.

Headset with loudspeaking



Press to toggle between headset with or without loudspeaking

Headset to handsfree



Press



Press the headset key

Note: Function key pre-programmed by system administrator.

Handsfree to headset



Press the headset key

Note: Function key pre-programmed by system administrator.

Direct Inward System Access (DISA) (optional)

If you are assigned to use this function and you are working externally, you can call your office and get access to an external line in order to make business calls. The business call will be charged your office extension number or an account number. You will just be charged for the call to the office.

The external telephone must be of push button type provided with hash (#) and star (*) keys or a mobile telephone adapted for dial tone pulses (DTMF).

After a completed DISA call you must hang up before a new DISA call can be made.

Depending on the type of authorization code and if an account code is used, different procedures must be used:

With common authorization code



Call the DISA function at your office

Dial tone.

*** 7 2 ***

Press



Enter the authorization code and press

Dial tone.



Dial the external number

With individual authorization code



Call the DISA function at your office

Dial tone.

*** 7 5 ***

Press



Enter the authorization code and press



Dial your own extension number and press

Dial tone.



Dial the external number

Name and number log (optional)

With this function all unanswered calls to your telephone will be logged. By use of the soft keys under the display you can browse the log, make calls to logged numbers and delete logged numbers.

A function key must be programmed by the system administrator. The key lamp is switched on and will flash when new unanswered calls have been logged, since last time the key was activated.

Your telephone must be idle and unlocked to be able to browse the log.

To browse the number log

Number log 

Press

Note: Function key pre-programmed by system administrator.

The key lamp is switched off and the display shows the number of stored numbers, time, date, name and number of the last unanswered call:

STORED NUMBERS: 2			
14:25	12FEB 2001	BOB SMITH	12345
NEXT	DEL	DIAL	EXIT

NEXT **Press to show the next logged number (see display)**

DEL **Press to delete the displayed number (see display)**

DIAL **Press to call the displayed number (see display)**

EXIT **Press to exit (see display)**

Paging (optional)

Persons equipped with a wireless paging receiver or assigned to a lamp signal, can be paged from a telephone set. Depending on the type of paging system it is possible to send digit messages or voice messages to the paged person.

Paging can also be initiated and answered during an ongoing call. Make an Inquiry call and proceed according to the appropriate procedure for the type of connected paging system. You can then either return to the ongoing call or transfer the paging call to the person that was put on hold. If this person is an external subscriber, your exchange must be programmed for this function.

If you receive a congestion tone when paging, this indicates that the paged person has his paging receiver in the charging rack and is probably out of the office.

Paging receivers without a display and paging via lamp signals

To initiate

When there is no answer or a busy tone, keep the handset off hook:

7

Press

Wait for an answer with the handset off hook.

If you want to start paging without calling the person:

*** 8 1 ***

⊙ ⊙ ⊙
 ⊙ ⊙ ⊙ #
 ⊙

Press

Dial the extension number and press

Wait for an answer with the handset off hook.

To answer

From any telephone within the system and within the predetermined paging time:

*** 8 2 ***

Press

 **#**

Dial your own extension number and press

Or if only one paging call is permitted at the time:

*** 8 2 #**

Press

Paging receivers with a display

To initiate

When there is no answer or a busy tone, keep the handset off hook:



Press and replace the handset

Wait for the paged person to call back.

If you want to start paging without calling the person:

*** 8 1 ***

Press

 **#**

Dial the extension number and press

Wait for the acknowledgement tone.



Replace the handset

Wait for the paged person to call back.

If you want to send a digit message code:

*** 8 1 ***

Press

⓪ ⓪ ⓪
⓪ ⓪ ⓪ *
⓪

Dial the extension number and press

⓪ ⓪ ⓪ #
⓪ ⓪ ⓪
⓪

Dial the message code (1-10 digits) and press

Wait for the acknowledgement tone.



Replace the handset

If expected, wait for the paged person to call back.

To answer

From the nearest telephone within the system: Call the extension number shown in the display of your paging receiver. If zeros are shown it indicates that you are being paged from an external subscriber. To answer:

*** 8 2 ***

Press

⓪ ⓪ ⓪ #
⓪ ⓪ ⓪
⓪

Dial your own extension number and press

Or if only one paging call is permitted at the time:

*** 8 2 #**

Press

If a message code is shown in the display, take the appropriate action.

Paging receivers with voice message

To initiate

When there is no answer or a busy tone, keep the handset off hook:

7

Press

Leave your message after the tone. Just before the predetermined speech time is ended, a warning tone will be heard.

If you want to start paging without calling the person:

*** 8 1 ***



#

Press

Dial the extension number and press

Leave your message after the tone. Just before the predetermined speech time is ended, a warning tone will be heard.

To answer

If your paging receiver has bothway voice connection, press the answer button to speak. If no bothway connection exists, take the appropriate action according to the message or answer the paging in the same way as paging without a voice message.

Alarm paging

To initiate

✳ **8 1 0** ✳

Press



Dial the extension number and press

Wait for the acknowledgement tone.



Replace the handset

If you want to send an alarm message code:

✳ **8 1 0** ✳

Press



Dial the extension number and press



Dial the message code (1-5 digits) and press

Wait for the acknowledgement tone.



Replace the handset

To acknowledge an alarm

You must acknowledge the alarm to be terminated:

✳ **8 2 0** ✳

Press



Dial your own extension number and press

To acknowledge an alarm for another extension:

✳ **8 2 0** ✳

Press



Dial the other extension number and press



Dial your own extension number and press

Authority

Data privacy

Data privacy allows you to make a call without any disturbances, i.e. intrusion. This function is automatically cancelled when the call is finished.



Order

Lift the handset

✖ 4 1 #

Press and dial the number

Do not disturb, DND

When you activate DND, calls to your extension are not indicated. Outgoing calls can be made as usual.

DND

Press to activate or deactivate DND (see display)

Note: You can also press DND (function key pre-programmed by system administrator) or use the procedure below.

✖ 2 7 #

Dial to activate

Special dial tone.

or

2 7

Dial to deactivate



Press to finish activation/deactivation

Note: If your telephone is programmed with "Multiple Directory Diversion and Do not disturb" (ask your system administrator), DND is ordered and cancelled simultaneously on all lines. (This function is only available in newer versions of the telephone exchange).

Group do not disturb

If your extension is defined as a master extension (programmed by system administrator), you can mark a group of extensions as Group do not disturb. The group can be bypassed by you.

* 2 5 *



Order

Press and dial the group number

Note: Germany and South Africa-press * 2 8 * No.

#

Press

Special dial tone.



Press

Cancel

2 5 *



Press and dial the group number

Note: Germany and South Africa-press # 2 8 * No.



Press

Bypass

* 6 0 *



Press and dial the extension number

#

Press

The call is made to the specified extension in the group.

Authorization code, common (optional)

If you are assigned to use a common authorization code (1 to 7 digits) you can temporarily change any used telephone within the exchange to the authority level connected to this code. You can use the code for one call only or you can open the phone for some calls and lock it when leaving the phone.

To use for a single call

*** 7 2 ***

Press

⓪⓪⓪
⓪⓪⓪ #
⓪

Enter authorization code and press

Verification tone.

Note: You can also press *AUTH* (see display), enter the code and press *ENTER* (see display).

⓪⓪⓪
⓪⓪⓪
⓪⓪⓪
⓪

Dial the digit or digits to get an external line and the external number

To open an extension for some calls

7 3 *

Press

⓪⓪⓪
⓪⓪⓪ #
⓪

Enter authorization code and press

Verification tone.

Note: You can also press *OPEN* (see display), enter the code and press *ENTER* (see display).

To lock an extension

*** 7 3 ***

Press

⓪⓪⓪
⓪⓪⓪ #
⓪

Enter authorization code and press

Verification tone.

Note: You can also press *LOCK* (see display), enter the code and press *ENTER* (see display).

Authorization code, individual (optional)

If you are assigned to an individual authorization code (1 to 7 digits, affiliated to your own extension) you can lock your own extension to a common authority level, e.g. when out of the office. You can also temporarily change any other used telephone within the exchange to the same authority level as you have on your own phone.

The individual code can be changed from your own extension.

To lock your telephone

✳ 7 6 ✳

⓪⓪⓪
⓪⓪⓪ #
⓪

Press

Enter authorization code and press

Verification tone.

Note: You can also press *LOCK* (see display), enter the code and press *ENTER* (see display).

To make calls with your authority level when your telephone is locked

✳ 7 5 ✳

⓪⓪⓪
⓪⓪⓪ #
⓪

Press

Enter authorization code and press

Verification tone.

Note: You can also press *AUTH* (see display), enter the code and press *ENTER* (see display).

⓪⓪⓪
⓪⓪⓪
⓪

Dial the digit or digits to get an external line and the external number

To open your telephone

7 6 *

Press

⓪⓪⓪
⓪⓪⓪ #
⓪⓪⓪
⓪

Enter authorization code and press

Verification tone.

Note: You can also press OPEN (see display), enter the code and press ENTER (see display).

To assign your own authority level to another telephone

* 7 5 *

Press

⓪⓪⓪
⓪⓪⓪ *
⓪⓪⓪
⓪

Enter authorization code and press

Verification tone.

Note: You can also press AUTH (see display), enter the code and press ENTER (see display).

⓪⓪⓪
⓪⓪⓪ #
⓪⓪⓪
⓪

Dial your own extension number and press

Verification tone.

⓪⓪⓪
⓪⓪⓪
⓪⓪⓪
⓪

Dial the digit or digits to get an external line and the external number

To change your individual authority code

* 7 4 *

Press

⓪⓪⓪
⓪⓪⓪ *
⓪⓪⓪
⓪

Enter old authorization code and press

⓪⓪⓪
⓪⓪⓪ #
⓪⓪⓪
⓪

Enter new authorization code and press

Verification tone.

Programming and Adjustments

Programming of functions

Frequently used functions and telephone numbers can be programmed on the function keys for easy access. When you want to use the function, just press the key. Certain functions must be pre-programmed by the system administrator.

Program or change a function



Program

Press



Press selected function key

Note: *If the key is already programmed, the number or function will be displayed.*



Enter telephone number or a function code according to the list on the next page

Note: *If a wrong number is entered, press the Clear key to erase it, and then enter the number again.*



Press the function key again



Program

Press to finish programming

Remove the transparent cover and write the function name or telephone number beside the key.

Note: *To erase a programmed function, press the Clear key, instead of the telephone number or function code, in the sequence above.*



Program

Verify a programmed number or function

Press



Press selected function key

The stored number or function is displayed.



Program

Press

Functions and required data

Function	Function code or Associated number			
	<i>Most common</i>	<i>Finland</i>	<i>France</i>	<i>Sweden</i>
Call pick up:				
Group	8		4	6
Individual	No. + 8		No. + 4	No. + 6
Call waiting	5	6	6	4
On hold, common	8		4	6
Conference	3			
Dial by a function key	Extension No.			
Flexible night service	* 8 4 * 0 * + External line number + #			
Intrusion on busy extension	4		8	8

Functions that need to be programmed by the system administrator:

- Additional lines
- Automatic callback
- Dedicated intercom link
- Diversion
- Do not disturb
- External line
- Free on 2nd access
- Immediate speech connection
- Individual external line
- Last external number redial
- Malicious call tracing
- Manual message waiting
- Multiple representation
- Name and number log

Programming of ringing signals

You have 6 programmable ringing signals on your telephone. The different signals can be programmed on access lines, additional lines and multiple represented lines.



Program

Press



Access 1

Press the corresponding line key

A digit (0-6) is shown in the display.

(0-6)

Select the ringing signal you want to use according to the list below

0 = Silent.

1 = Periodic ringing signal.

2 = Delayed periodic ringing signal.

3 = One muted ringing signal.

4 = One muted delayed ringing signal.

5 = Immediate speech connection with single tone burst controlled by function key.

6 = Immediate speech connection with single tone burst.

Note: Options 5 and 6 are not available for multiple represented lines.



Access 1

Press



Program

Press to finish programming



Press to clear the display during programming

To verify a ringing signal



Program

Press



Access 1

Press the corresponding line key

A digit (0-6) is shown in the display.



Program

Press to finish programming

Programming of ringing signal tone character

There are 10 different programmable ringing signal tone characters on your telephone, each corresponding to a digit between 0 and 9.

Note: *If you use melodies to signal incoming calls, this will replace the tone character. See section "Melody ringing".*



Program

Press

The current tone character is displayed.

(0-9)

Press the corresponding digit

The telephone rings with the chosen character.



Program

Press to finish programming

Handset and loudspeaker volume

Use the volume keys to change the volume of the handset or loudspeaker during a call. Adjust handset listening volume in handset mode. Adjust loudspeaker volume in monitor mode.



Press to change the volume

Ringling signal volume

Use the volume keys to adjust the ringing signal volume when the telephone is idle or ringing. Adjusted volume is stored.



Press to change the volume

Mute ringing signal

You can suppress the ringing signal for an incoming call.

Note: *This function is only available in newer software versions of your telephone. If the Mute key lamp is turned on when you press the key in idle state, your telephone supports this function.*



Press to suppress the ringing signal

The ringing signal is switched off for the current call.

Silent ringing

If you do not want to be disturbed by the ringing signal but still want to be able to answer an incoming call, you can switch off the ringing signal. Incoming calls are only indicated by a flashing access line lamp and display information.

Note: *This function is only available in newer software versions of your telephone. If the Mute key lamp is turned on when you press the key in idle state, your telephone supports this function.*



Press to switch off the ringing signal

The Mute key lamp is switched on to indicate silent ringing. The ringing signal will automatically be switched on the next time you lift the handset or press any key.

Melody ringing

If you want personal melodies when your telephone rings, you can program one melody to signal an internal call, a second melody for an external call and a third melody to signal a callback call.

Note: *This function is only available in newer software versions of your telephone. If you can enter "Melody mode", your telephone supports this function.*



Press and hold simultaneously to enter melody mode

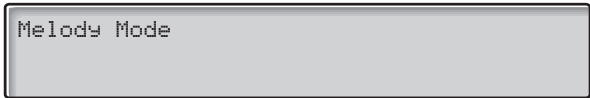

If there is a stored and activated melody for internal calls (Access 1 key), external calls (Access 2 key) or callback calls (Inquiry key), the corresponding key lamp is switched on.

In melody mode you can:

- Program new melodies
- Edit or delete stored melodies
- Activate or deactivate stored melodies

Press to exit melody mode

Note: *If you do not press any key within 30 seconds, melody mode is automatically cancelled.*

Program a new melody, edit or delete a current melody



Press





Access 1

Press the key for the requested type of call:

If there is a current melody, the melody is played and the last 19 notes or signs are displayed.

Press for internal calls

or



Access 2

Press for external calls

or



Inquiry

Press for callback calls

To edit the current melody:



Move the cursor to the right of the position to be edited

Keep pressed to go to the beginning or to the end.



Press to erase the note to the left of the cursor

Keep pressed to erase all the notes.

To enter a new melody or new notes, see section "To enter notes".

To store the current melody:



Press the flashing line key (Access 1 or Access 2 or Inquiry)



Program

Press

The current melody is stored.

Note: *The melody is not activated, see section "Activate or deactivate a stored melody".*

To delete the current melody:



Press and hold until no notes are displayed



Press the flashing line key (Access 1 or Access 2 or Inquiry)



Program

Press

Activate or deactivate a stored melody

A stored melody has to be activated in melody mode to be heard when you get an incoming call.

To activate (in melody mode):



Press the key for the requested type of call (Access 1 or Access 2 or Inquiry)

The corresponding key lamp is switched on:

Access 1 key = Internal calls

Access 2 key = External calls

Inquiry key = Callback calls

Note: *If you want to return to an ordinary ringing signal but keep the melody stored, just press the key for the requested type of call again. When key lamp is off the stored melody is deactivated.*

Press to exit melody mode

To enter notes

In melody mode, the keypad is used to enter notes, pauses, etc. A maximum of 40 notes can be programmed for incoming calls, and 20 notes for recalls.

1c 2d 3e
4f 5g 6a
7b 8+c 9+d

This is how the keys are used:

Press to insert notes (1-9)

Note: *A short press gives a short note, a long press gives a long tone (displayed by a capital letter), +c and +d means the higher octave.*

*** Press to insert a short pause (p)**

Hold to get a long pause (P). Repeat to get a longer pause (pp...p).

0 Press to get a higher octave for the inserted note

A + is shown in front of the note to indicate the higher octave.

Example: 30 to get +e

Press to increase or decrease the pitch for the inserted note

Press once for sharp pitch, twice for flat pitch and three times to get the normal pitch.



Press to move the cursor to the left or to the right

Keep pressed to go to the beginning or to the end.



Press to listen to the entered notes



Press to erase the note to the left of the cursor

Keep pressed to erase all the notes.

Melody example:

James Bond theme programmed for Internal calls:

C d d D D pp C C C C #d #d #D #D pp D D D ##A G pppp G F G

1 2 2 2 2 * * 1 1 1
 1 2 # 2 # 2 # 2 #
 * * 2 2 2 6 # # 5
 * * * * 5 4 5

Enter the notes

Grey digit = Long press.

Note: The # key (to get a sharp or flat tone) is pressed after the note, but is displayed before the note.

When the first 19 positions are entered, the display shows (only last entered 19 positions can be shown):

```
Program Intern
CddDDFFCCCC#d#d#D#D<
```

When all the notes are entered, the display shows (only last entered 19 positions are shown):

```
Program Intern
#D#DFFDDDbAGFFFFFG<
```

Note: The flat A (##A) is shown as bA, i.e. b is used to show both the note b and the flat sign.

Audible Signals

The following different tones and signals are sent from the exchange to your telephone.

Tone characteristics

The tones shown in this section are the most used tones worldwide. Many markets use a differing tone for one or more situations. If you get a tone that is not described or you cannot identify, ask your system administrator.

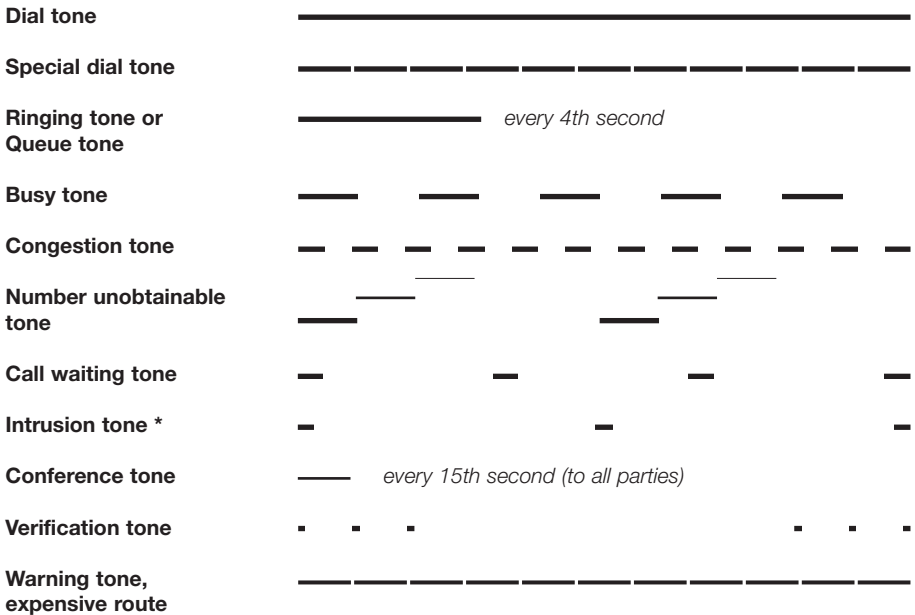

* Intrusion tone is only available on newer versions of the telephone exchange.

Ringling signals

Three different ringing signals inform you about the type of the incoming call. The signals shown in this section are the most used signals worldwide. Many markets use signals that are adapted for the local standards. If you get a signal that is not described or you cannot identify, ask your system administrator.

Internal ringing signal



External ringing signal



Recall signal

*(automatic callback
reminder)*



Visible Signals

Lamp indications



Extinguished lamp

The function is not active.



Steady light

Function is active or supervised
line is busy.



Slowly flashing lamp

The line (or function) is put on hold.



Rapidly flashing lamp

An incoming call.



Light with short breaks

Ongoing call.

Display Information

The display gives you feedback information such as time and date, traffic state and connected telephone numbers. The following displays show examples of the different states your telephone is in.

Idle telephone

When your phone is idle, the upper line shows general information. The middle line shows your extension number. The lower line presents lead texts for the soft keys.

	14:25	12FEB 2001	
			2222
OPEN	ACC	AUTH	TIMER

Outgoing call

When you make an outgoing call on your telephone, the middle line shows both the traffic state and dialled number.

	14:25	12FEB 2001	
CALLING			3333
CAB			TIMER

If the called party's telephone is diverted, the middle line shows the diversion information.

	14:25	12FEB 2001	
	33333 DIV DIR.		55555
CAB			TIMER

The dialled number (3333) is directly diverted to number 5555.

Incoming call

When you receive an incoming call the middle line flashes the calling party's extension number.

```
14:25      12FEB 2001  
33333
```

If a diverting extension is calling, the middle line shows the diversion information. The calling party's number is flashing.

```
14:25      12FEB 2001  
44444 DIV DIR.      22222
```

Number 22222 has dialled number 44444 and the call is directly diverted to you.

Soft keys

The soft keys are used to access different functions. Depending on which traffic state and category of extension, the available functions change.

The following abbreviations are used for the soft keys:

ACC	Account code
AUTH	Authorization code
CAB	Callback
CAW	Call waiting
CONF	Conference (only shown when there is a party put on hold)
COST	Display charging information
CUP	Call pick-up
DATE	Show date
DEL	Delete
DIAL	Call the number displayed
DOWN	Scroll down
DND	Do not disturb
ETE	Dialling during a connected call (Push button tones, DTMF)
EXIT	Exit the displayed menu
INTR	Intrusion
LNR	Last number redial
LOCK	Lock the telephone
MCT	Malicious call tracing
NEXT	Show next logged number
OPEN	Unlock the telephone
PAG	Paging
PICK	Group call pick-up
RST	Reset time measurement
SP	Enter a space when writing names
SRCH	Search
START/STOP	Start/Stop time measurement
TIME	Display time measurement
TIMER	Timer
UP	Scroll up

Choice of language (optional)

One of the following languages can be chosen to be used for the display information on your telephone.

Digit 0-9 = the language code:

0 English 1 French 2 German 3 Spanish 4 Italian
5 _____ 6 _____ 7 _____ 8 _____ 9 _____

Note: *By default 5-9 are programmed for English. To be changed locally to other languages.*

To choose a language

*** 0 8 ***

Press

(0-9)

Enter the language code



Press

Option Unit/Vocabulary

Option unit

The Option unit DBY 410 02 is an optional accessory, to be installed under your telephone set. The following devices can be installed via the Option unit:

- Tape recorder
- Extra bell or busy signal outside your door
- Headset or conference unit

Note: *Regarding the headset functions see section "Other useful facilities".*

- Second handset

Note: *For people with impaired hearing the Option unit offers the possibility to amplify the receiving volume in the handset and headset.*

Vocabulary

Additional lines	One or more additional extension numbers can be assigned to your telephone, these are programmed on free function keys.
Idle message	A message shown in the display when the telephone is idle. This message is programmed by your system administrator.
Multiple represented line	Your extension number can be represented on a function key on other extensions (two or more).
Triple access line	A collective name for the Access 1, Access 2 and Inquiry lines. Access 1 and Access 2 forms your extension number and are available both for incoming and outgoing calls. Inquiry can only be used for outgoing calls.

Installation

Install stand and adapt telephone

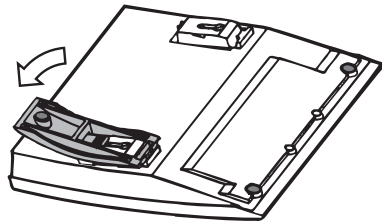
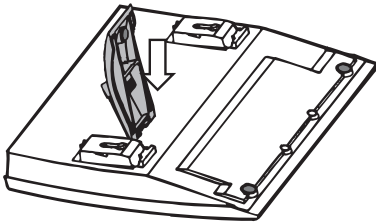

Press to decrease angle

Pull to increase angle

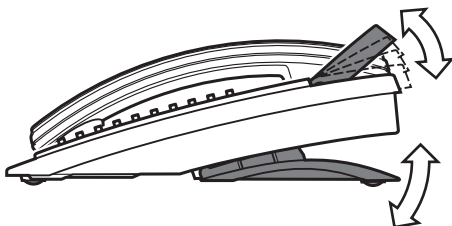
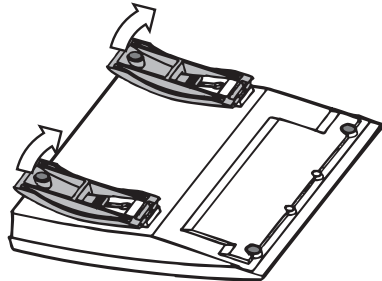
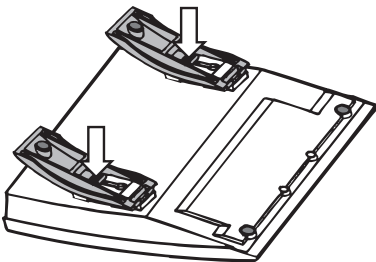

Tiltable display

Adjustable angle

Install cables

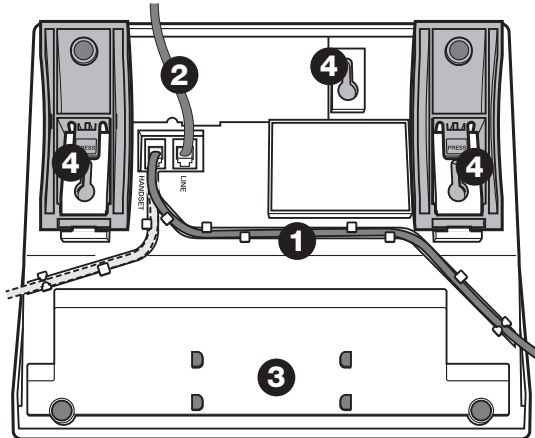

- 1 Cable to handset
- 2 Cable to exchange
- 3 Space for personal directory list(optional)
- 4 Wallmounting screw holes
- 5 Template holes for wallmounting of telephone (copy this page).

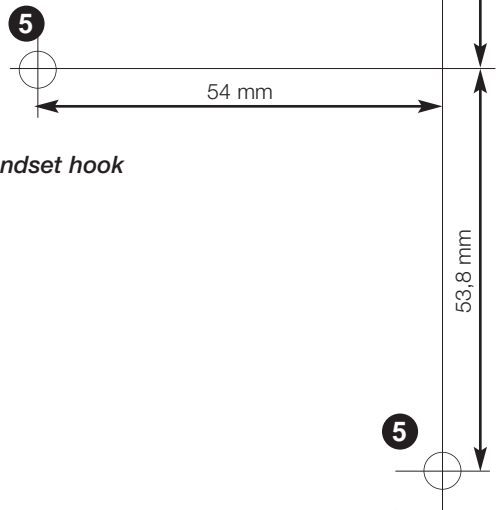

Wall mounting handset hook

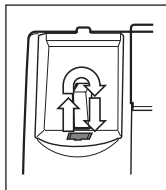

Install keypanel

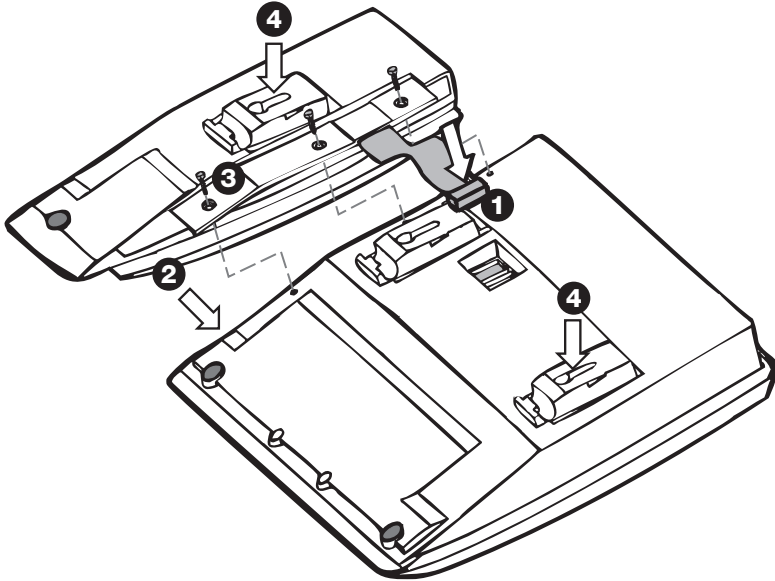

- 1** Remove the small plastic plate, marked DSS, i.e. with a screwdriver and connect the cable
- 2** Attach key-panel unit
- 3** Secure with screws
- 4** Install stand

Labels

Copy these labels and use the copies for your own labelling.

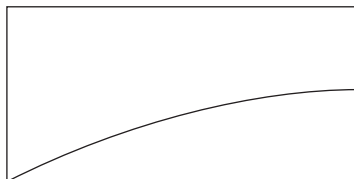

<i>Dialog 3213</i>	
MD119	
Program	• Menu
	•
	•
	•
	•
	•
	•
	•
	•
	•
Transfer	•
	•
Inquiry	•
	•
Access 2	•
	•
Access 1	•

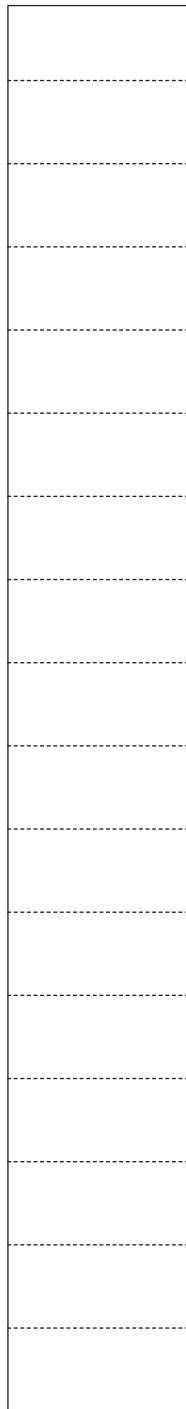

Index

- Abbreviated numbers 39
- Absence information 37
- Account code 48
- Additional directory number 52
- Alarm extension 51
- Alarm paging 61
- Answer calls 6
- Audible signals 76
- Authority 62
- Authorization code, common 64
- Authorization code, individual 65
- Automatic callback 17
- Busy extension or external line 17
- Bypass diversion 26
- Call forwarding 21
- Call metering 44
- Call pick-up group 46
- Call waiting 19
- Charging information 44
- Choice of language 82
- Common abbreviated numbers 39
- Common bell group 46
- Conference 14
- Data communication 51
- Data privacy 62
- Description 4
- Dial by a function key 43
- Dial-by-name 41
- Dialling during a connected call 16
- DISA 55
- Display information 79
- Diversion 21
- Do not disturb, DND 62
- DTMF signals 16
- During calls 11
 - Conference 14
 - Conversation via the handset 12
 - DTMF signals 16
 - Handsfree conversation 12
 - Handsfree to loudspeaking 11
 - Hold 15
 - Inquiry 13
 - Loudspeaking to handsfree 11
 - Microphone on or off 12
 - Send caller's identity code 16
 - Transfer 14
- Emergency state 51
- External follow-me 26
- Functions and required data 68
- General cancellation 49
- Group do not disturb 63
- Group facilities 46
- Group hunting 47
- Group listening (loudspeaking) 11
- Handset and loudspeaker volume 70
- Handset to handsfree 12
- Handsfree to handset 12
- Headset 53
- Hot line 51
- Immediate speech connection 49

- Incoming calls 6
 - Answer a second call 7
 - Handsfree 6
 - On Access 1 6
 - On another extension 7
 - On any other line key 6
- Individual abbreviated numbers 39
- Information 37
- Inquiry 13
- Installation 84
- Integrated voice mail 34
- Internal follow-me 24
- Internal messages 32
- Intrusion on a busy extension 19
- Labels 87
- Lamp indications 78
- Language 82
- Mailbox 36
- Make calls 8
- Malicious call tracing 53
- Manual message waiting (MMW) 32
- Melody ringing 72
- Message waiting 33
- Messages 32
- Multiple represented directory number 52
- Mute 12
- Mute ringing signal 71
- Name and number log 56
- Night service 50
- On hold 15
- Option unit 83
- Other useful facilities 48
- Outgoing calls 8
 - External calls 8
 - Handsfree 9
 - Individual external line 9
 - Internal calls 8
 - Last external number redial 9
 - Save external number 10
- Paging 57
 - Alarm paging 61
 - Paging receivers with a display 58
 - Paging receivers with voice message 60
 - Paging receivers without a display and paging via lamp signals 57
- Personal number 27
- Programming and adjustments 67
- Programming of functions 67
- Programming of ringing signal tone character 70
- Programming of ringing signals 69
- Put a call on hold 15
- Redial number 9
- Refer back 13
- Ringing signal volume 70
- Ringing signals 77
- Send caller identity code at transfer 16
- Setting form for search profiles 31
- Short numbers 39
- Silent ringing 71
- Timer 44
- Tone characteristics 76
- Transfer 14
- Visible signals 78
- Vocabulary 83
- Voice mail 34
- Volume 70
- When you receive a busy tone 17
 - Call waiting 19
 - Callback 17
 - Intrusion 19

Copy this easy guide and put it in the optional pull-out leaf underneath your telephone.

Note: This easy guide shows the most common function codes. Differing codes for specific markets are not shown.

Function	Activate	Deactivate
Automatic callback		
Busy extension or no reply	6	#37* extension No. #
Busy external line	6 external No. #	#37* line digit #
Cancel all callbacks		#37#
Bypass diversion	*60* phone No. #	
Call pick-up		
Common bell group	CUP or 8	
Group	CUP or 8	
Individual	Extension No. CUP or 8	
Call waiting	CALL or 5	
Conference	CONF or 3	
Data privacy	*41# phone No.	
Diversion		
From your own extension	*21#	#21#
From answering position	*21* own * new #	#21* own #
On no answer	*21#	#211#
On busy	*212#	#212#
To other service facility	*218#	#218#
Do not disturb	DND or *27#	DND or #27#
Do not disturb, group	*25* group No. #	#25* group No. #
Bypass	*60* extension No. #	
Follow-me external	*22# line digit + external No. #	#22#
Follow-me internal		
From your own extension	*21* extension No. #	#21#
From answering position	*21* own * new #	#21* own #
General cancellation	#001#	
Ind. abbreviated No.	***(0-9)	
To erase a No.		#51*(0-9)#
To erase all abbr. No.		#51#
To program & alter	*51*(0-9)* phone No. #	
Intrusion (extension)	INT or 4	
Intrusion (external line)	*44* ind. external line No. # line digit 4	
Last external No. redial	**#	
Malicious call tracing	*39#	
Manual message waiting	*31* extension No. #	#31#
Night service		
Flexible	*84* line digit * external No. #	#84#
Universal	CUP or 8	
On hold	CUP or 8	CUP or 8

Ericsson communications solutions

for enterprise networks combine and improve advanced ways of exchanging information via voice, data, video and evolving future media.

This requires a true understanding of how businesses and professionals interact – an understanding that goes far beyond meeting just the technological requirements.

Our customers include owners of small to large enterprise networks, local as well as multinational. We also offer solutions for Internet service providers.

We deliver quality of service over converged networks. We provide staff with full onsite and offsite mobility.

We integrate computer and telephony applications on the desktop. We enable coordination of all business interactions over the media of choice. In essence, we help businesses forge enduring relationships with customers.

Ericsson is the leading provider in the new telecoms world, with communications solutions that combine telecom and datacom technologies with the freedom of mobility for the user. With more than 100,000 employees in 140 countries, Ericsson simplifies communications for its customers - network operators, service providers, enterprises and consumers - the world over.